

1938 LINCOLN LOG DESIGN BOOK

For 5/8-in. Logs

9 3/4 in. wide by 13 in. tall

4 Numbered Pages

Plus the

Addendum for the Complete Set

1 Unnumbered Page

LINCOLN LOG DESIGN BOOK

ONLY LINCOLN LOGS have these EXCLUSIVE and PATENTED FEATURES

DESIGN BOOK COPYRIGHT-1938

J. L. WRIGHT, INC.

NAME REGISTERED AUGUST 28, 1923

U. S. PATENTS 1,351,086 AND 2,012,160

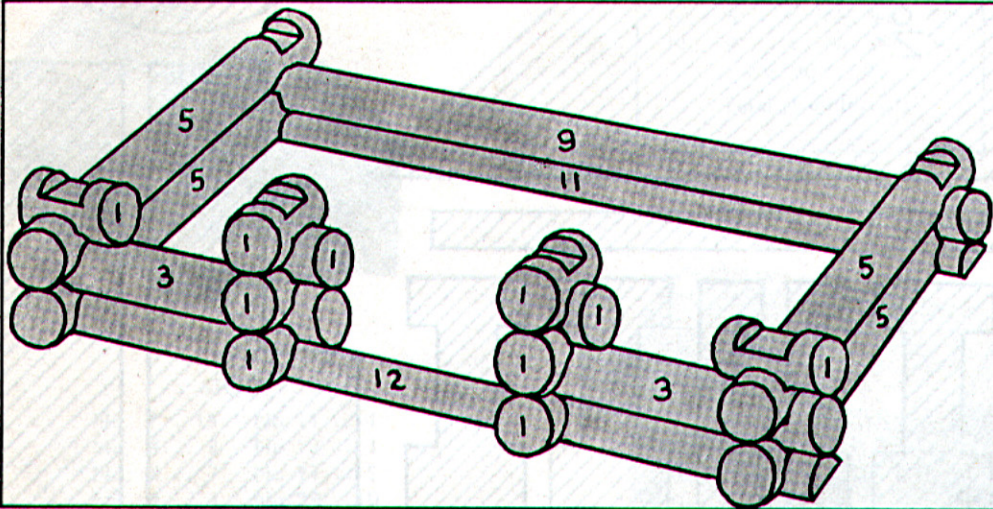

LINCOLN LOG FOUNDATION PLAN SHOWN ABOVE

How to Start Your Building:

1st. Pick out the half Logs No. 12 and No. 11. Flat side down, round side up, these half Logs are used to form the front and back of the base of the building.

2nd. Connect the ends of the half Logs with two No. 5 Logs.

3rd. Lay a No. 9 Log over No. 11.

4th. Place a No. 1 Log in each of the middle notches of No. 12 and connect them with the No. 5 Logs by two No. 3 Logs.

5th. Follow the numbers shown in the diagram; then read about the other construction features illustrated on this Page and you will be ready to build the structures shown on Pages 3 and 4. Before long you will be designing your own buildings. Rubber bands may be used to hold them together, if desired.

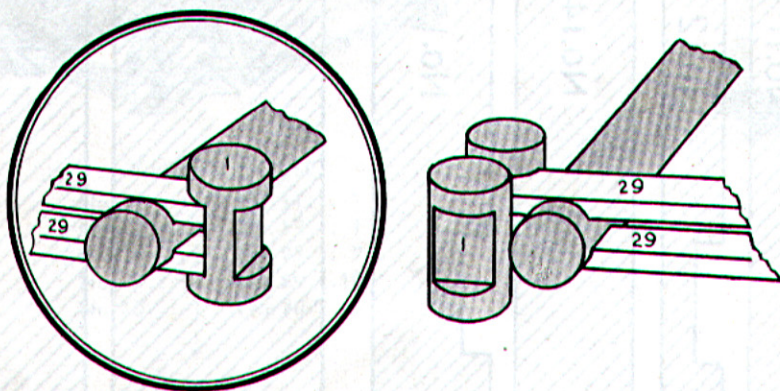

A NEW DEVELOPMENT IN LINCOLN LOG CONSTRUCTION is the use of the narrow roof planks No. 29 as beams or girders by placing two of the planks in the opposite notches of a Log, as shown in the above illustrations, and locking the ends together with No. 1 or other Logs. The planks and Logs thus locked together may be placed either vertically or horizontally to build towers, bridges, fences, platforms, etc., as illustrated within. When both ends of a pair of planks are thus locked together, the elasticity of the planks provides enough tension to hold the pieces securely.

INTRODUCTION

The building designs shown herein are simple and easy to understand but they represent merely a few suggestions. The possible combinations of Lincoln Logs are without end as the Logs are designed on a multiple unit system that is based on their diameter which is $\frac{5}{8}$ ". The Logs are interlocking at windows, doors and corners to make buildings more solid. *The numbers of the Logs and other pieces are given on Page 2, actual sizes being shown.*

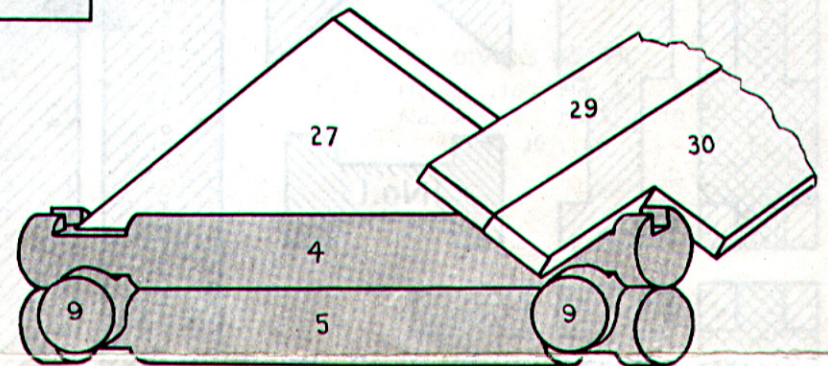

GABLE AND ROOF CONSTRUCTION

The new patented Lincoln Log gable and roof is illustrated above. When the sides and ends of your building have reached the desired height, place a slotted Log No. 4 on the uppermost Logs at the ends of the building to receive the triangular gable No. 27. Then place the bottom roof planks No. 30 on the lower corners of the gable and against the outer edges of the notches in the slotted Logs, as shown in the diagram, and place other roof planks No. 29 above them on the gables to complete the roof.

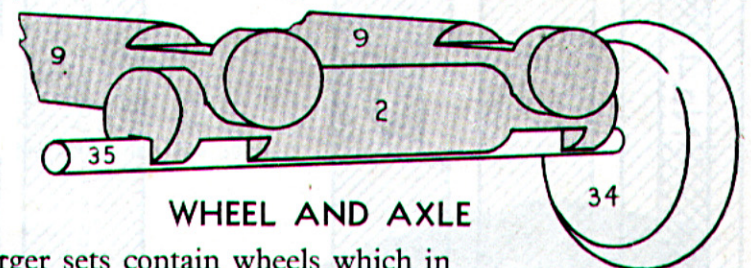

WHEEL AND AXLE

The larger sets contain wheels which in the early days were made from cross sections of Logs. Among the first things made with wheels were the wheel barrow, hand truck and the ox cart. Later on man designed the wagon and the automobile. These can be made from the larger set of Lincoln Logs as shown on Page 4. The new grooved Logs No. 2 are used as bearings for the axle, No. 35, on the ends of which are placed the wheels, No. 34. These wheels are held securely to the axle by friction while the axle turns freely in the groove. Longer Logs are then placed in the notches of the No. 2 Logs to form the chassis on which the desired body may be constructed.

DIAGRAM OF PIECES

Actual Size

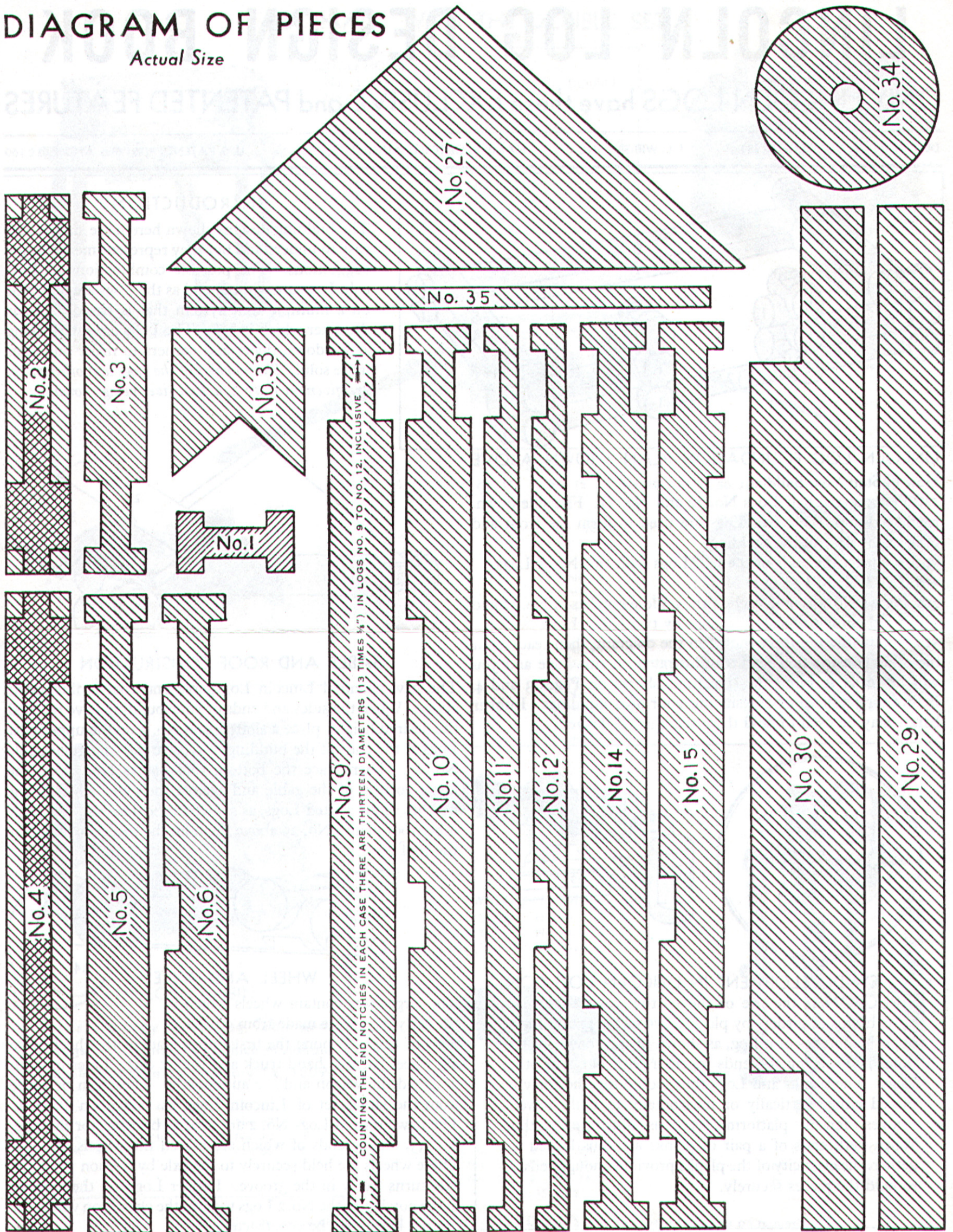

These Structures Can Be Made with the Single Set

CONTENTS OF SINGLE SET

No. 1...16	No. 10... 1
No. 3... 2	No. 11... 1
No. 4... 2	No. 12... 1
No. 5... 8	No. 27... 2
No. 9... 4	No. 29...10
No. 30... 2	
Total of 49 Pieces	

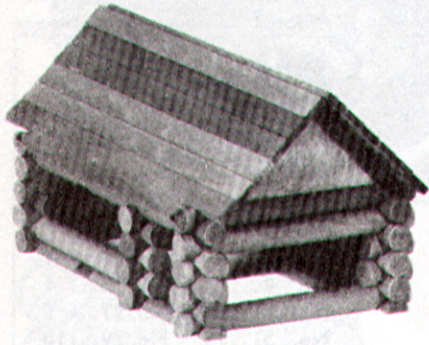

STORE

No. 1...15	No.11... 1
No. 4... 2	No.12... 1
No. 5... 7	No.27... 2
No. 9... 4	No.29...10
No.10... 1	No.30... 2

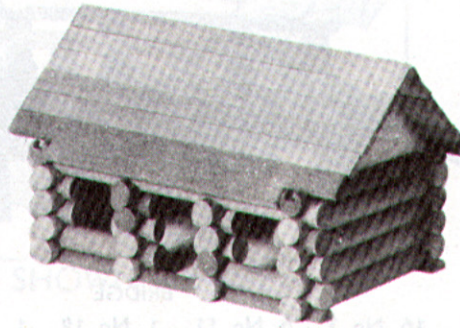

PIONEER CABIN

No. 1...16	No. 10... 1
No. 3... 2	No. 11... 1
No. 4... 2	No. 12... 1
No. 5... 8	No. 27... 2
No. 9... 4	No. 29...10
No. 30... 2	

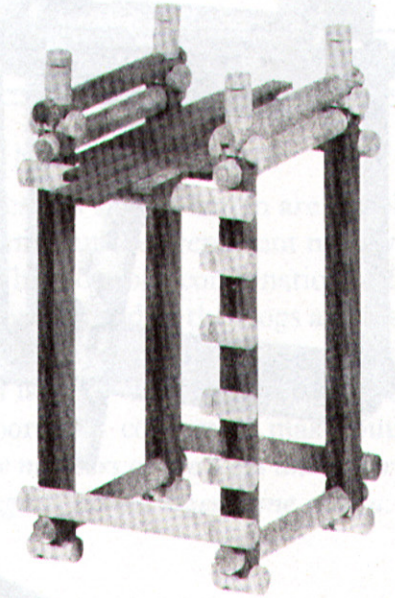

DIVING TOWER

No. 1...16	No. 5... 8
No. 4... 2	No.29...10
No.30... 2	

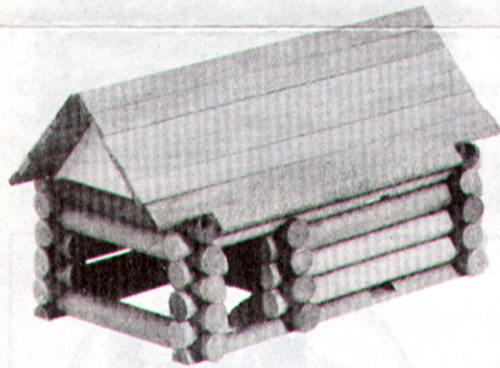

SCHOOL HOUSE

No. 1...15	No.11... 1
No. 4... 2	No.12... 1
No. 5... 7	No.27... 2
No. 9... 4	No.29...10
No.10... 1	No.30... 2

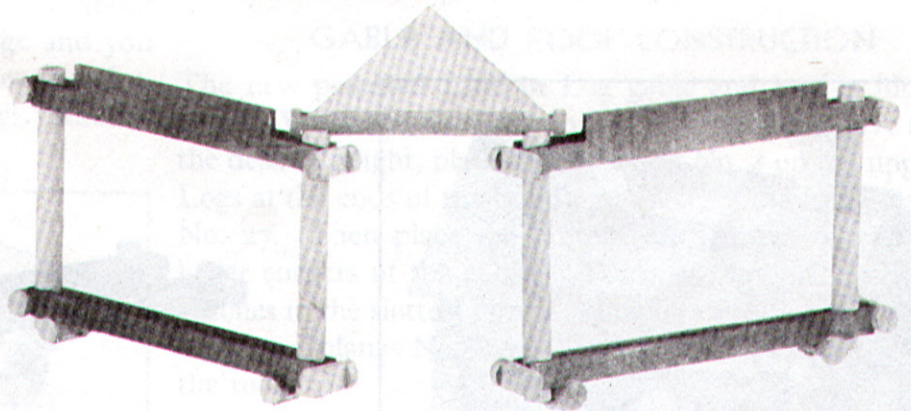

ARCH

No. 1...12	No. 27... 1
No. 4... 1	No. 29... 6
No. 5... 4	No. 30... 2

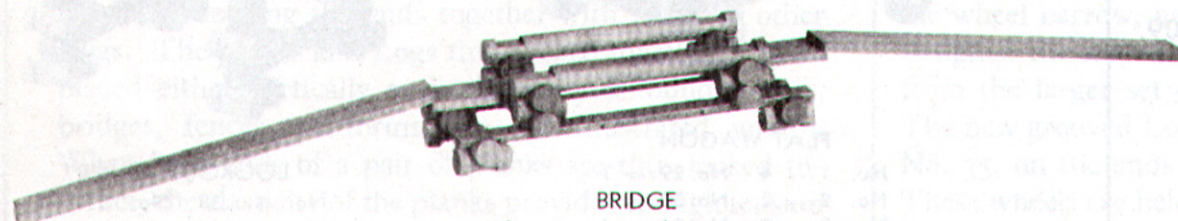

BRIDGE

No. 1...16	No. 11... 1
No. 3... 2	No. 12... 1
No. 5... 2	No. 29... 6

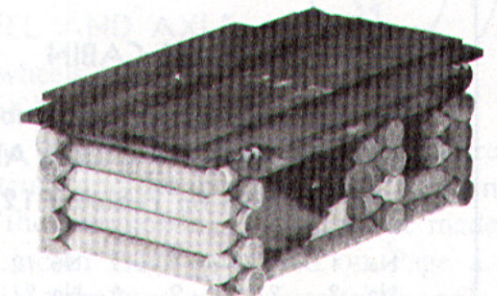

MACHINE SHED

No. 1...11	No. 10... 1
No. 3... 1	No. 11... 1
No. 4... 2	No. 12... 1
No. 5... 8	No. 29... 7
No. 9... 4	No. 30... 2

ALL OF THESE STRUCTURES TOGETHER WITH THOSE SHOWN ON PAGE THREE CAN BE MADE WITH THE DOUBLE SET

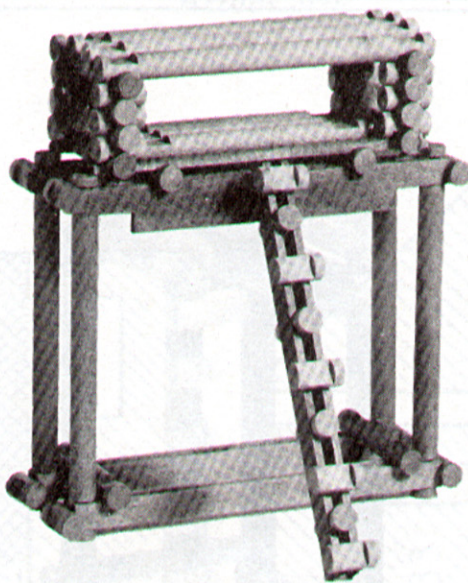

JUNGLE HOUSE

- No. 1...37
- No. 3... 8
- No. 5... 3
- No. 9... 6
- No.10... 2
- No.11... 1
- No.12... 1
- No.29... 8
- No.30... 2

CONTENTS OF DOUBLE SET	
No. 1...39	No.11... 1
No. 2... 2	No.12... 1
No. 3... 8	No.27... 2
No. 4... 2	No.29...10
No. 5...15	No.30... 2
No. 6... 2	No.33... 1
No. 9... 6	No.34... 4
No.10... 3	No.35... 2
Total of 100 Pieces	

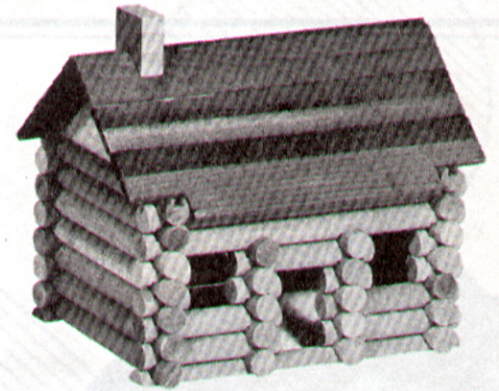

UNCLE TOM'S CABIN

- No. 1...26
- No. 3... 7
- No. 4... 2
- No. 5...12
- No. 9... 3
- No.10... 3
- No.11... 1
- No.12... 1
- No.27... 2
- No.29...10
- No.30... 2
- No.33... 1

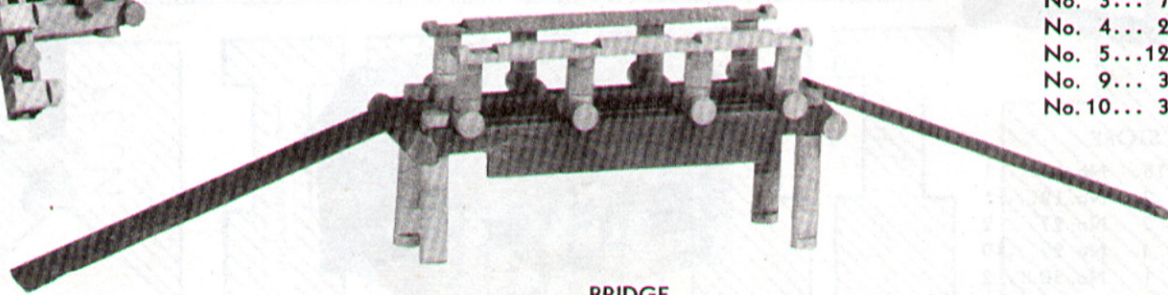

BRIDGE

- No.1...16, No. 3...6, No. 11...1, No. 12...1, No. 29...8, No. 30...2

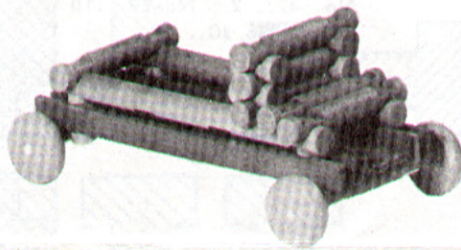

WAGON

- No. 1... 8
- No. 2... 2
- No. 3... 6
- No.10... 2
- No.29... 8
- No.34... 4
- No.35... 2

TWO STORY CABIN

- No. 1...34
- No. 3... 2
- No. 4... 2
- No. 5...15
- No. 6... 1
- No. 9... 6
- No.10... 3
- No.11... 1
- No.12... 1
- No.27... 2
- No.29...10
- No.30... 2
- No.33... 1



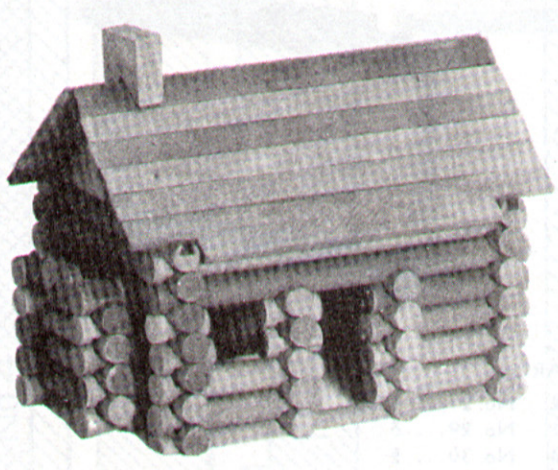

LINCOLN CABIN

This is a copy of the Log Cabin near Hodgenville, Kentucky in which Abraham Lincoln was born on February 12, 1809.

No. 1...27	No. 5...12	No.12... 1
No. 2... 2	No. 9... 6	No.27... 2
No. 3... 8	No.10... 2	No.29...10
No. 4... 2	No.11... 1	No.30... 2
No.33.....1		

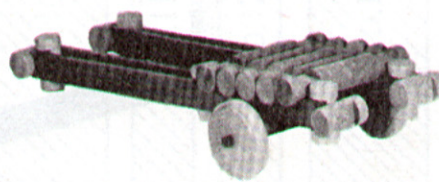

WHEEL BARROW

- No. 1...10
- No. 2... 1
- No. 3... 5
- No.29... 4
- No.34... 2
- No.35... 1

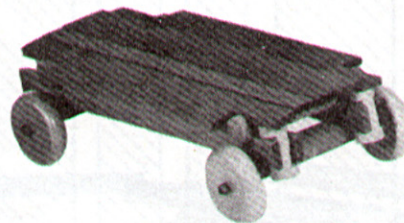

FLAT WAGON

- No. 1... 4
- No. 2... 2
- No. 3... 2
- No.29... 7
- No.30... 2
- No.34... 4
- No.35... 2

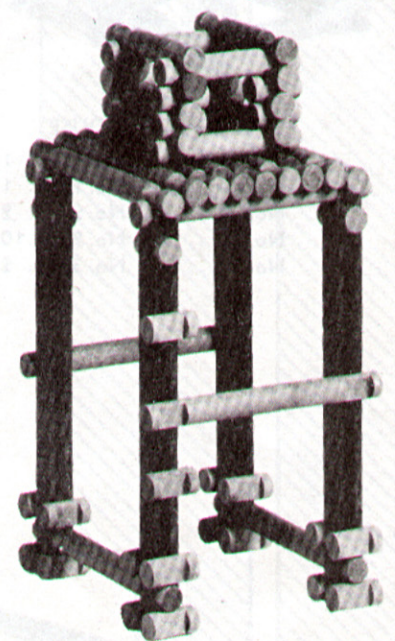

LOOKOUT TOWER

- No. 1...38
- No. 3... 8
- No. 5...15
- No. 29...8

Complete catalogue of LINCOLN LOGS and ALLIED TOYS will be gladly furnished on request
J. L. WRIGHT, INC., Merchandise Mart, Chicago, Illinois

ALL STRUCTURES SHOWN ON THIS PAGE AS WELL AS THOSE SHOWN IN THE DESIGN BOOK CAN BE MADE WITH THE COMPLETE SET OF LINCOLN LOGS



- TWO STORY BLOCKHOUSE**
- | | |
|-------------|-------------|
| No. 1...43 | No. 10... 4 |
| No. 3...15 | No. 11... 2 |
| No. 4... 2 | No. 12... 2 |
| No. 5...14 | No. 14... 4 |
| No. 6... 1 | No. 15... 2 |
| No. 7... 1 | No. 27... 2 |
| No. 8... 1 | No. 29...10 |
| No. 9... 4 | No. 30... 2 |
| No. 33... 1 | |

CONTENTS OF COMPLETE SET

- | | |
|-------------|-------------|
| No. 1...67 | No. 14... 4 |
| No. 2... 2 | No. 15... 2 |
| No. 3...15 | No. 17... 2 |
| No. 4... 2 | No. 25... 6 |
| No. 5...16 | No. 26... 2 |
| No. 6... 3 | No. 27... 2 |
| No. 7... 1 | No. 29...10 |
| No. 8... 1 | No. 30... 2 |
| No. 9... 7 | No. 31...10 |
| No. 10... 4 | No. 32... 2 |
| No. 11... 2 | No. 33... 2 |
| No. 12... 2 | No. 34... 4 |
| No. 35... 2 | |

Total of 172 Pieces

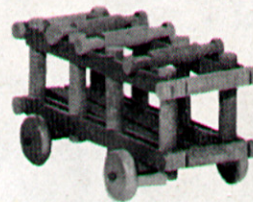

- CIRCUS WAGON**
- | | |
|-------------|-------------|
| No. 2... 2 | No. 29...10 |
| No. 3...15 | No. 34... 4 |
| No. 35... 2 | |

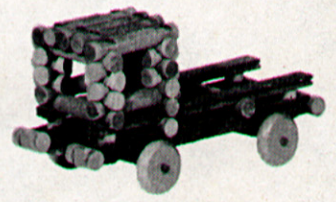

- DELIVERY TRUCK**
- | | |
|------------|-------------|
| No. 1...20 | No. 29...10 |
| No. 2... 2 | No. 34... 4 |
| No. 3...15 | No. 35... 2 |

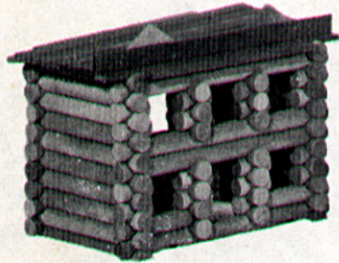

COMBINATION STORE AND FLAT BUILDING

- | | |
|------------|-------------|
| No. 1...53 | No. 9... 5 |
| No. 3... 6 | No. 10... 4 |
| No. 5...13 | No. 14... 2 |
| No. 6... 1 | No. 26... 2 |
| No. 7... 1 | No. 29... 8 |
| No. 8... 1 | No. 30... 2 |

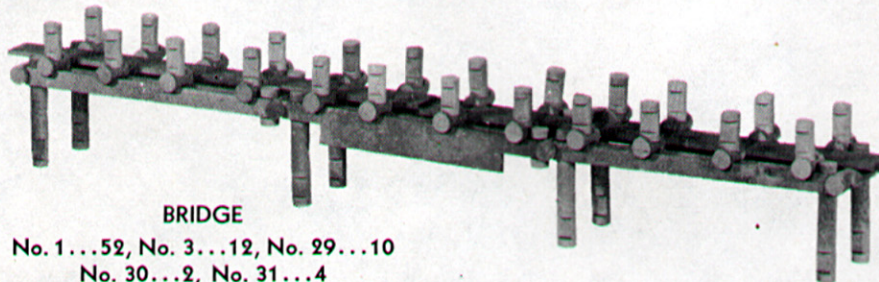

- BRIDGE**
- | |
|-------------------------------------|
| No. 1...52, No. 3...12, No. 29...10 |
| No. 30...2, No. 31...4 |

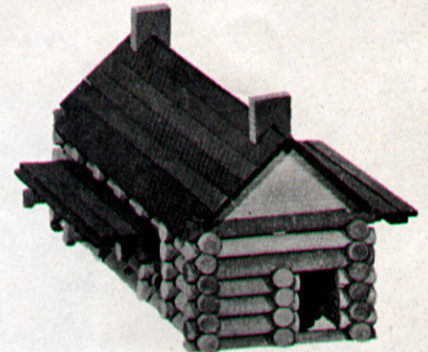

SUBURBAN STATION

- | | |
|------------|-------------|
| No. 1...56 | No. 17... 2 |
| No. 3... 9 | No. 25... 6 |
| No. 4... 2 | No. 27... 2 |
| No. 5...12 | No. 29... 8 |
| No. 6... 2 | No. 31...10 |
| No. 7... 1 | No. 32... 2 |
| No. 8... 1 | No. 33... 2 |



OVERSEER'S HOME

- | | |
|------------|-------------|
| No. 1...53 | No. 9... 6 |
| No. 3...11 | No. 10... 3 |
| No. 4... 2 | No. 14... 1 |
| No. 5...12 | No. 15... 1 |
| No. 6... 1 | No. 27... 2 |
| No. 7... 1 | No. 29...10 |
| No. 8... 1 | No. 30... 2 |

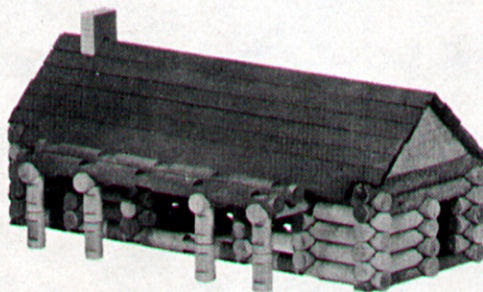

RANCH HOUSE

- | | |
|-------------|-------------|
| No. 1...41 | No. 8... 1 |
| No. 3...13 | No. 17... 2 |
| No. 4... 2 | No. 25... 4 |
| No. 5...10 | No. 27... 2 |
| No. 6... 1 | No. 31...10 |
| No. 7... 1 | No. 32... 2 |
| No. 33... 1 | |

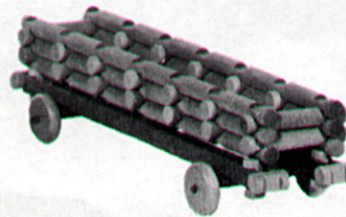

TRAILER

- | | |
|-------------|-------------|
| No. 1...28 | No. 25... 6 |
| No. 2... 2 | No. 31... 4 |
| No. 3... 4 | No. 34... 4 |
| No. 35... 2 | |

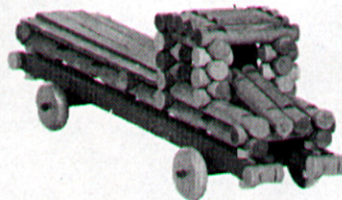

LUMBER TRUCK

- | | |
|-------------|-------------|
| No. 1...24 | No. 25... 2 |
| No. 2... 2 | No. 29... 5 |
| No. 3...15 | No. 31... 4 |
| No. 6... 2 | No. 34... 4 |
| No. 35... 2 | |

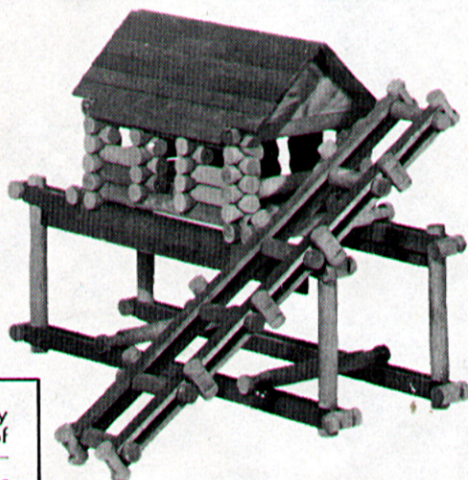

BOAT HOUSE

- | | |
|-------------|-------------|
| No. 1...56 | No. 11... 1 |
| No. 3...14 | No. 12... 1 |
| No. 4... 2 | No. 27... 2 |
| No. 5...12 | No. 29...10 |
| No. 9... 6 | No. 30... 2 |
| No. 10... 3 | No. 31...10 |
| No. 32... 2 | |

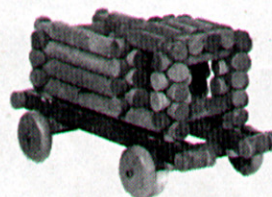

COAL TRUCK

- | | |
|------------|-------------|
| No. 1...18 | No. 10... 2 |
| No. 2... 2 | No. 29... 4 |
| No. 3...14 | No. 34... 4 |
| No. 5... 6 | No. 35... 2 |

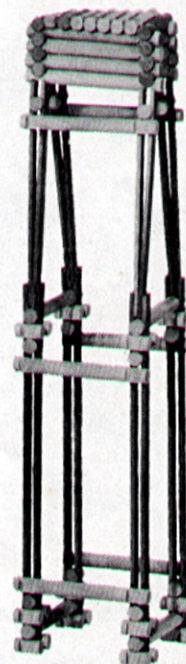

RAILWAY WATCHMAN'S TOWER

- | |
|-------------|
| No. 1...36 |
| No. 3...15 |
| No. 5...16 |
| No. 6... 2 |
| No. 29... 8 |
| No. 31... 8 |

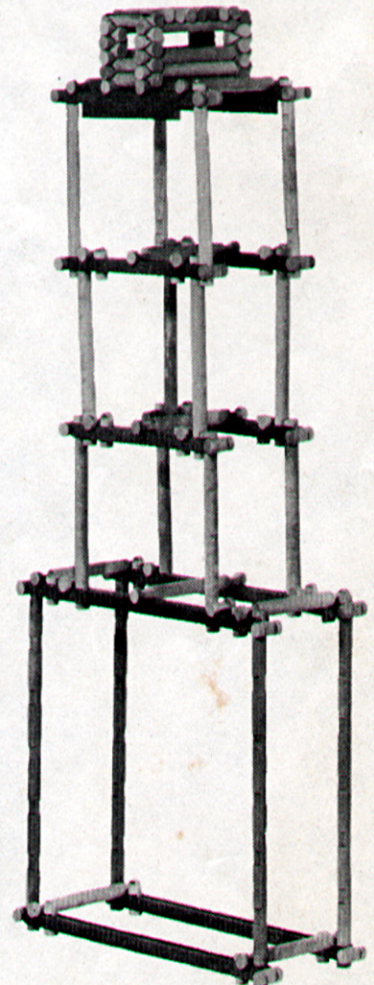

BRIDGE TOWER

- | | |
|-------------|-------------|
| No. 1...60 | No. 10... 1 |
| No. 3...13 | No. 14... 4 |
| No. 5...16 | No. 25... 4 |
| No. 6... 1 | No. 29...10 |
| No. 9... 7 | No. 30... 2 |
| No. 31... 8 | |

● To secure additional play value, you should have plenty of Lincoln Log Historical Figures—Soldiers of 1776 and 1812, Pioneers, Cowboys, Canadian Mounties, Farm Animals, etc., as illustrated in our colored catalog which will be gladly sent on request.

J. L. WRIGHT, Inc.
1443 MERCHANDISE MART,
CHICAGO, ILLINOIS

Makers of Lincoln Logs and Allied Toys