

1944 LARGE LINCOLN LOG AND TIMBER DESIGN BOOK

For 3/4-in. Logs and Timbers

9 ³/₄ in. wide by 13 in. tall

4 Numbered Pages

LARGE LINCOLN LOG AND TIMBER DESIGN BOOK

ONLY LINCOLN LOGS AND TIMBERS HAVE THESE EXCLUSIVE AND PATENTED FEATURES
THE ALL AMERICAN WOOD CONSTRUCTION TOY • NO NAILS REQUIRED

DESIGN BOOK COPYRIGHT-1944 LINCOLN LOGS NAME REGISTERED AUGUST 28, 1923 U. S. PATENTS 1,351,086 AND 2,012,160

★ INTRODUCTION

The building designs shown herein are simple and easy to understand but they represent merely a few suggestions. The possible combinations of Lincoln Logs and Timbers are without end as they are designed on a multiple unit system that is based on a diameter of $\frac{3}{4}$ ". The Logs and Timbers are interlocking at windows, doors and corners to make buildings more solid. The identifying numbers of the Logs, Timbers and other pieces are given on Page 2, actual sizes being shown.

Lincoln Timbers are identical with Large Lincoln Logs except that they are square instead of round. The Logs and Timbers are interchangeable and wherever the word "Log" is used in these instructions, the word "Timber" may be substituted.

Sets 1L, 2L and 3L consist mostly of round Logs. Sets 1T, 2T and 3T are entirely Timbers. Set 5LTF is a combination of Logs and Timbers together with Miniature Figures, and a Mesh Bag, serving as a container for the Logs and Timbers when not in use.

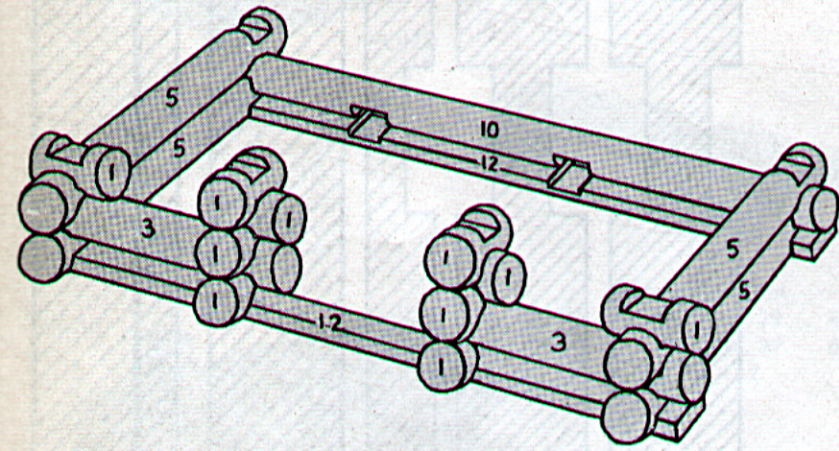

★ LINCOLN LOG FOUNDATION PLAN SHOWN ABOVE

How to Start Your Building

1st. Pick out the half Logs No. 12. Flat side down, notched side up, these half Logs are used to form the front and back of the base of the building.

2nd. Connect the ends of the half Logs with two No. 5 Logs.

3rd. Lay a No. 10 Log over No. 12 at the rear.

4th. Place a No. 1 Log in each of the middle notches of No. 12 at the front and connect them with the No. 5 Logs by two No. 3 Logs.

5th. Follow the numbers shown in the diagram; then read about the other construction features illustrated on this Page and you will be ready to build the structures shown on Pages 3 and 4. Before long you will be designing your own buildings. Rubber bands may be used to hold them together, if desired.

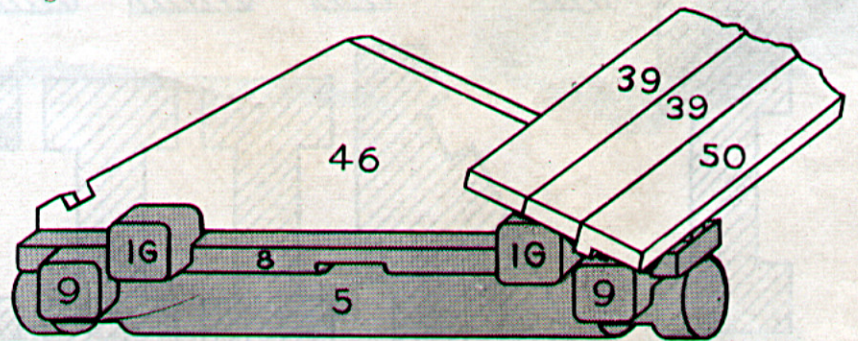

★ GABLE AND ROOF CONSTRUCTION

The new Lincoln Log Gable and Roof is illustrated above. When the sides and ends of your building have reached the desired height, place a No. 8 Timber on the uppermost Logs at each end of the building to receive two No. 1G Logs which hold the gable in position. Then place the roof planks No. 50 on the lower corners of the gable with the projection on the plank fitting in the notch on the gable. Place roof planks, No. 39 above them on the gables to complete the roof.

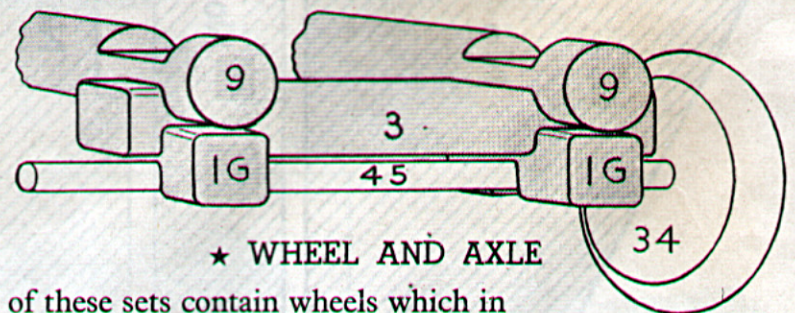

★ WHEEL AND AXLE

All of these sets contain wheels which in the early days were made from cross sections of Logs. Among the first things made with wheels were the wheelbarrow, hand truck and the ox cart. Later on man designed the wagon and the automobile. Two grooved Logs No. 1G are used as bearings for the axle, No. 45, on the ends of which are placed the wheels, No. 34. These wheels are held securely to the axle by friction while the axle turns freely in the groove. A No. 3 Log is placed parallel to the axle in the notches of the No. 1G Logs, and longer Logs are then placed in the notches of the No. 3 Logs to form the chassis on which the desired body may be constructed.

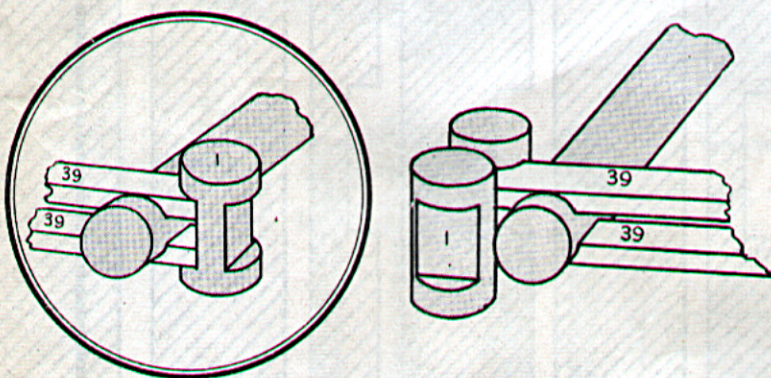

★ A NEW DEVELOPMENT IN LINCOLN LOG CONSTRUCTION is the use of the narrow roof planks No. 39 as beams or girders by placing two of the planks in the opposite notches of a Log, as shown in the above illustrations, and locking the ends together with No. 1 or other Logs. The planks and Logs thus locked together may be placed either vertically or horizontally to build towers, bridges, fences, platforms, etc., as illustrated within. When both ends of a pair of planks are thus locked together, the elasticity of the planks provides enough tension to hold the pieces securely.

DIAGRAM OF PIECES—Actual Size

Because of lack of space, the following pieces are not illustrated: Nos. 14 and 15, the same length as No. 9, but having more notches; No. 22, the longest Timber with six pairs of notches; No. 41 and 51, the longest roof planks; No. 45, the axle; and No. 47, the long gable, same length as No. 9 Log.

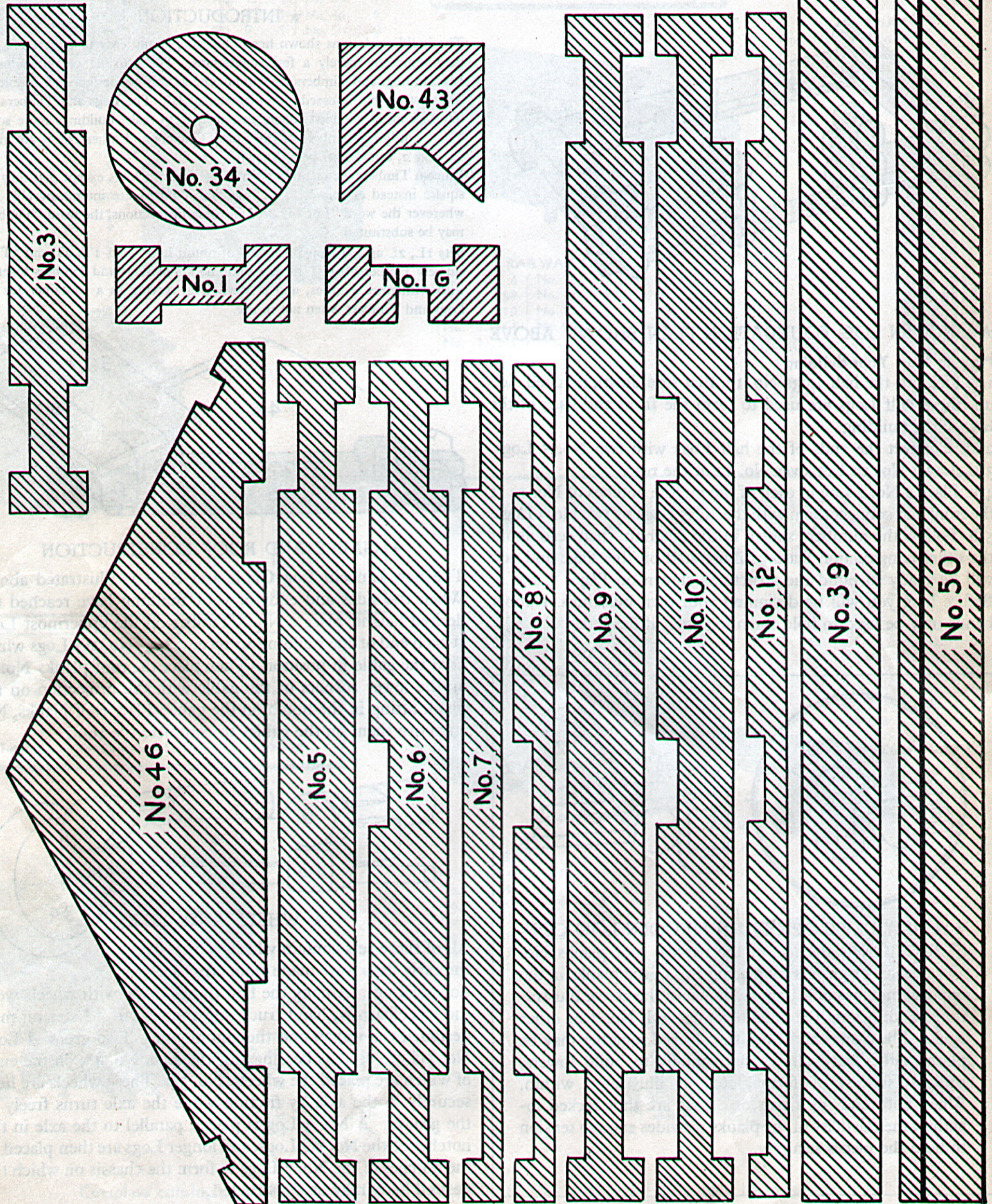

These Structures Can Be Made with Either the 1L or the 1T Set

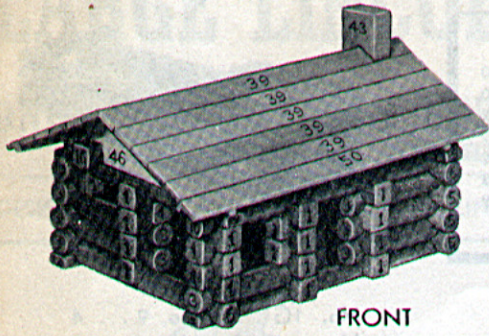

FRONT

CONTENTS OF 1L and 1T SETS			
No. 1G.... 4	No. 12.... 2		
No. 1....33	No. 34.... 4		
No. 3....10	No. 39....10		
No. 5.... 3	No.43.... 1		
No. 6.... 2	No.45.... 2		
No. 8.... 2	No.46.... 2		
No.10.... 2	No.50.... 2		
Total of 79 pieces			

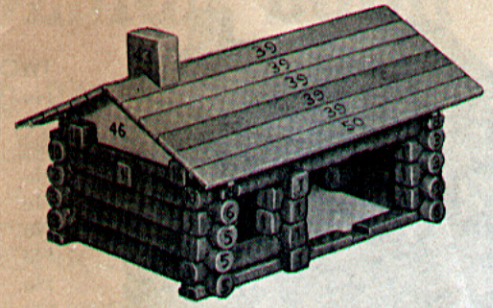

FRONT

PIONEER CABIN

No. 1G.. 4	No. 10... 2
No. 1...33	No. 12... 2
No. 3...10	No. 39...10
No. 5... 3	No. 43... 1
No. 6... 2	No. 46... 2
No. 8... 2	No. 50... 2

PONY EXPRESS STATION

No. 1G.. 4	No. 10... 2
No. 1...27	No. 12... 2
No. 3...10	No. 39...10
No. 5... 3	No. 43... 1
No. 6... 2	No. 46... 2
No. 8... 2	No. 50... 2

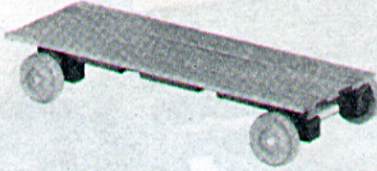

FLAT WAGON

No. 1G.. 4	No. 34... 4
No. 12... 2	No. 39... 6
No. 45... 2	

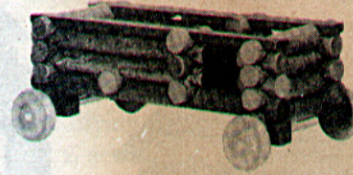

MILK TRUCK

No. 1G.. 4	No. 6... 2
No. 1...12	No. 10... 2
No. 3... 8	No. 12... 2
No. 5... 2	No. 34... 4
No. 45... 2	

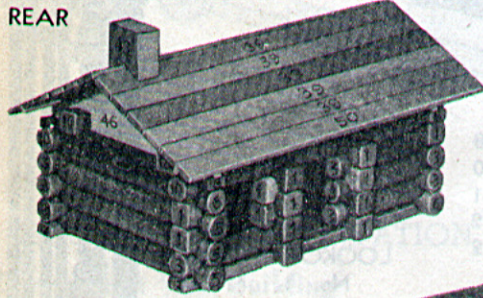

REAR

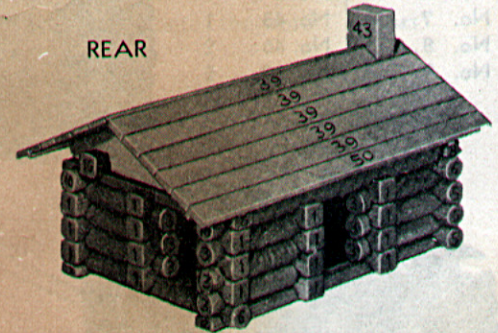

REAR



BRIDGE

No. 1...20	No. 5... 2
No. 3... 2	No. 12... 2
No. 39... 6	

These Structures, Together with Those Shown Above, and Many Others Can Be Made with Either the 2L or the 2T Set

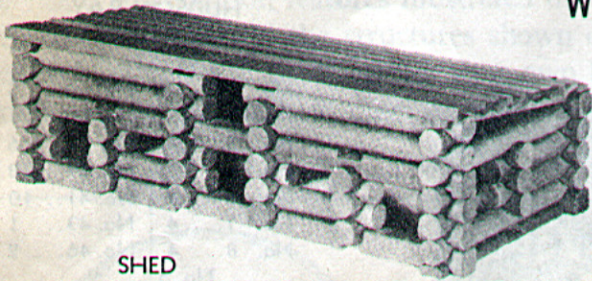

SHED

No. 1...47	No. 8... 3
No. 3... 4	No. 9... 2
No. 5... 8	No. 10... 1
No. 6... 2	No. 22... 4
No. 7... 1	No. 41... 9
No. 51... 1	

CONTENTS OF 2L and 2T SETS			
No. 1G.... 4	No. 22.... 4		
No. 1....56	No. 34.... 4		
No. 3....10	No. 39....10		
No. 5.... 9	No. 41....10		
No. 6.... 2	No. 43.... 2		
No. 7.... 1	No. 45.... 2		
No. 8.... 3	No. 46.... 2		
No. 9.... 2	No. 50.... 2		
No.10.... 4	No. 51.... 2		
No.12.... 9			
Total of 131 pieces			

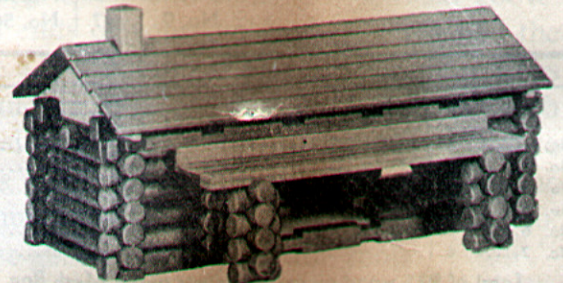

RANCH HOUSE

No. 1G.. 4	No. 7... 1	No. 39... 5
No. 1...46	No. 8... 3	No. 41...10
No. 3...10	No. 9... 1	No. 43... 1
No. 5... 8	No.10... 1	No. 46... 2
No. 6... 2	No. 22... 4	No. 51... 2

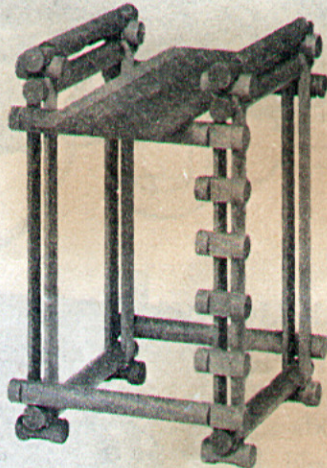

DIVING PLATFORM

No. 1...16	No. 6... 2
No. 5... 8	No. 39... 4
No. 41... 8	

CIRCUS WAGON

No. 1G.. 4	No. 9... 2
No. 1...23	No.10... 4
No. 3...10	No. 34... 4
No. 45... 2	

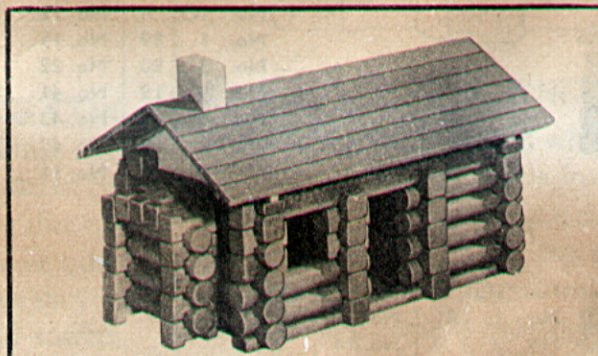
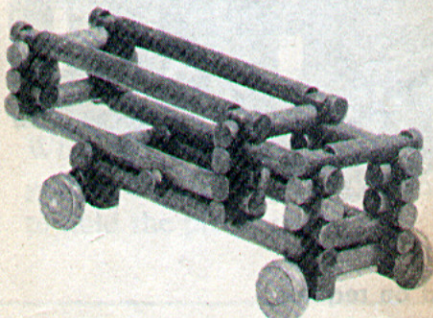

LINCOLN CABIN

No. 1G.. 4	No. 6... 2	No. 39...10
No. 1...49	No. 8... 2	No. 43... 1
No. 3...10	No.10... 2	No. 46... 2
No. 5... 9	No.12... 2	No. 50... 2

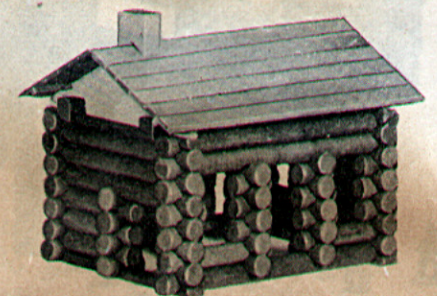

SCHOOL HOUSE

No. 1G.. 4	No. 6... 2	No. 39...10
No. 1...47	No. 7... 1	No. 43... 1
No. 3... 9	No. 8... 3	No. 46... 2
No. 5... 7	No. 9... 2	No. 50... 2
No. 10... 4		

This is a copy of the Log Cabin near Hodgenville, Kentucky in which Abraham Lincoln was born on February 12, 1809.

These Structures, Together with Those Shown on Page 3, Can Be Made with the 3L or the 3T Set

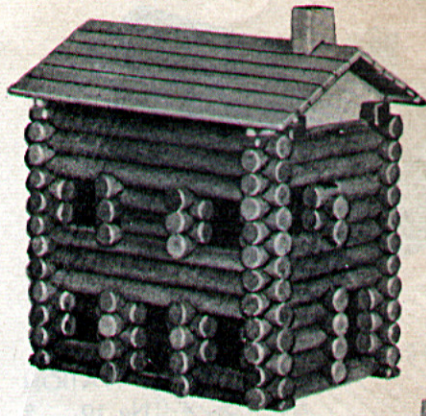

TWO STORY DWELLING

No. 1G... 4	No. 10... 4
No. 1... 47	No. 12... 2
No. 3... 13	No. 14... 1
No. 5... 15	No. 15... 2
No. 6... 3	No. 39... 10
No. 7... 1	No. 43... 1
No. 8... 1	No. 46... 2
No. 9... 7	No. 50... 2

CONTENTS OF 3L and 3T SETS

No. 1G... 4	No. 9... 7	No. 39... 10
No. 1... 77	No. 10... 4	No. 41... 10
No. 3... 14	No. 12... 2	No. 43... 2
No. 5... 16	No. 14... 4	No. 45... 2
No. 6... 3	No. 15... 2	No. 46... 2
No. 7... 1	No. 22... 6	No. 50... 2
No. 8... 3	No. 34... 4	No. 51... 2

Total of 177 pieces

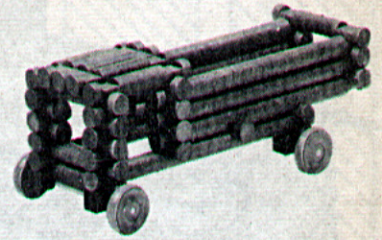

COAL TRUCK

No. 1G... 4	No. 9... 4
No. 1... 20	No. 10... 4
No. 3... 13	No. 34... 4
	No. 45... 2

MEETING HOUSE

No. 1G... 4	No. 10... 4
No. 1... 43	No. 12... 2
No. 3... 8	No. 14... 1
No. 5... 16	No. 39... 10
No. 7... 1	No. 43... 1
No. 8... 1	No. 46... 2
No. 9... 5	No. 50... 2

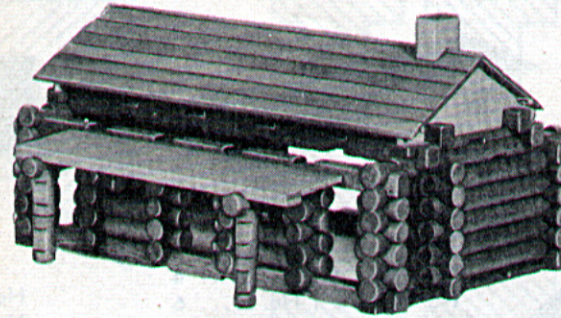
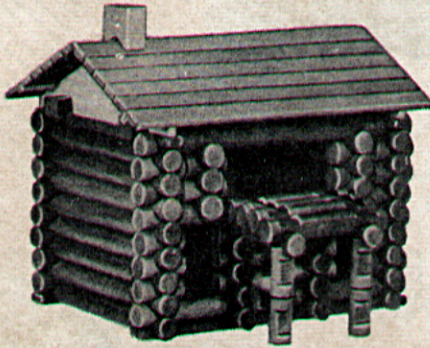

RAILWAY STATION

No. 1G... 4	No. 8... 1	No. 39... 8
No. 1... 68	No. 12... 2	No. 41... 10
No. 3... 10	No. 15... 2	No. 43... 1
No. 5... 14	No. 22... 6	No. 46... 2
No. 7... 1		No. 51... 2

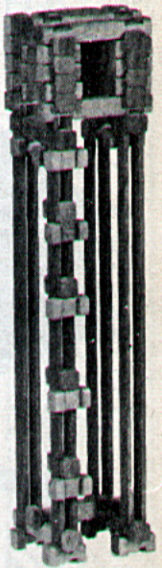

LOOKOUT TOWER

No. 1... 41
No. 3... 14
No. 41... 8

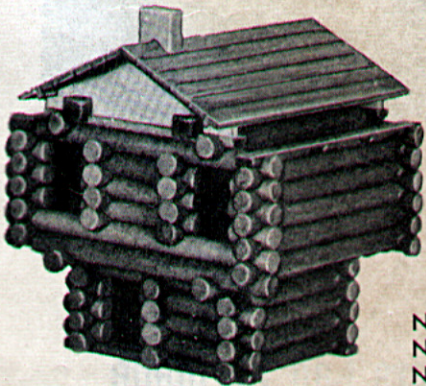

BLOCK HOUSE

No. 1G... 4	No. 10... 4
No. 1... 42	No. 12... 2
No. 3... 9	No. 14... 4
No. 5... 16	No. 15... 2
No. 6... 3	No. 39... 10
No. 7... 1	No. 43... 1
No. 8... 3	No. 46... 2
No. 9... 7	No. 50... 2

These Structures, together with all the others shown in the Design Book can be made with the De Luxe 5LTF Set, which Consists of Large Logs, Timbers and Miniature Figures.

CONTENTS OF DE LUXE 5LTF SET

No. 1G... 8	No. 8... 4	No. 15... 2	No. 43... 2
No. 1... 103	No. 9... 7	No. 22... 6	No. 45... 2
No. 3... 24	No. 10... 6	No. 34... 4	No. 46... 2
No. 5... 15	No. 12... 4	No. 39... 10	No. 47... 2
No. 6... 4	No. 14... 4	No. 41... 14	No. 50... 2
No. 7... 4		No. 51... 2	

Total of 231 wood pieces, 8 Figures and 1 Mesh Bag

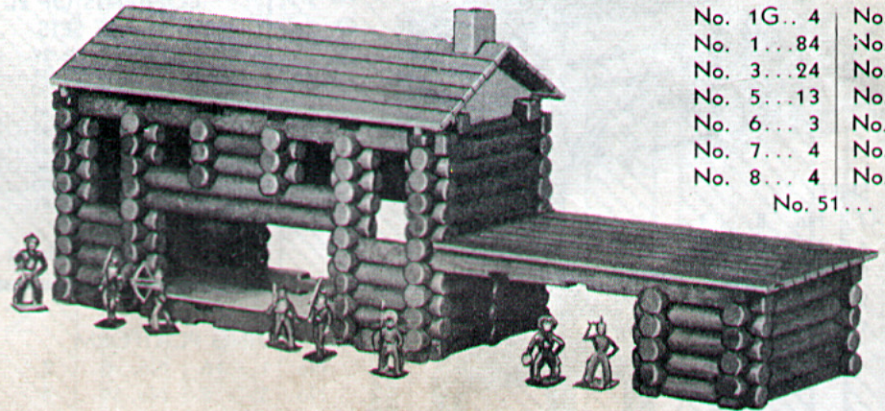

HUDSON BAY TRADING POST WITH STABLE

No. 1G... 4	No. 9... 5
No. 1... 84	No. 10... 1
No. 3... 24	No. 22... 6
No. 5... 13	No. 39... 8
No. 6... 3	No. 41... 10
No. 7... 4	No. 43... 1
No. 8... 4	No. 46... 2
	No. 51... 2

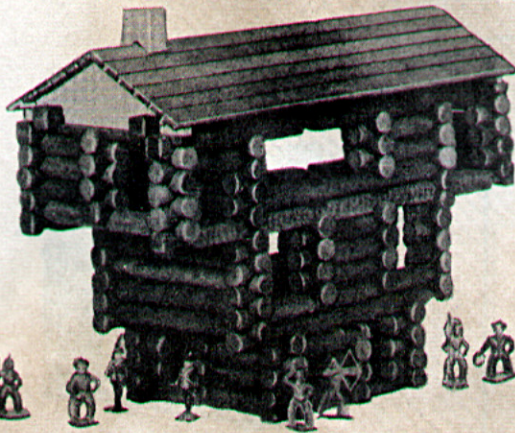

THREE STORY BLOCK HOUSE

No. 1G... 4	No. 9... 3
No. 1... 81	No. 10... 4
No. 3... 9	No. 14... 2
No. 5... 15	No. 22... 4
No. 6... 4	No. 41... 10
No. 7... 1	No. 43... 1
No. 8... 3	No. 46... 2
	No. 51... 2

BARN

No. 1G... 4	No. 12... 4
No. 1... 89	No. 15... 1
No. 3... 20	No. 22... 6
No. 5... 12	No. 41... 14
No. 6... 2	No. 43... 1
No. 9... 2	No. 47... 2
No. 10... 6	No. 51... 2

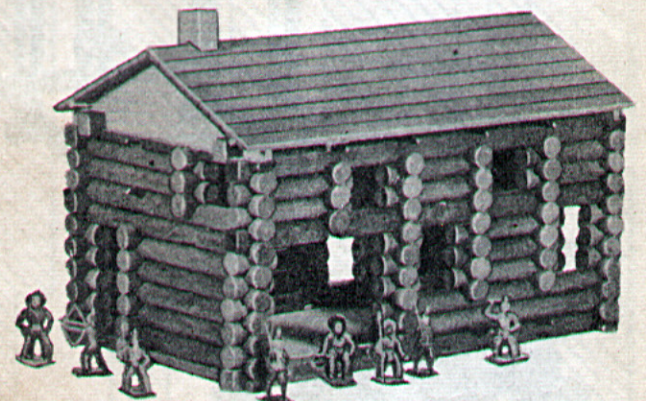

Complete catalog of LINCOLN LOGS and ALLIED TOYS will be gladly furnished on request
 LINCOLN LOGS, 1750 N. Lawndale Ave., Chicago 47, Illinois