

1952 to 1955  
ORIGINAL LINCOLN LOGS  
DESIGN BOOK

For 3/4-in. Logs

8 ½ in. wide by 15 in. tall

4 Pages



# AMERICA'S NATIONAL TOY

## Original LINCOLN LOGS

LINCOLN LOGS  
Reg. U.S. Pat. Off.

### DESIGN BOOK

U.S. PATENT NOS.  
1351086 and 2012160

#### INTRODUCTION

- ★ The simple, step by step instructions start the builder toward many different designs.
- ★ Lincoln Logs are designed on a multiple unit system that is based on a diameter of  $\frac{3}{4}$ ".
- ★ The suggested structures are but a few of the many possible building combinations.
- ★ Logs are interlocking at windows, doors and corners to make more sturdy buildings.
- ★ Identifying diagram of logs and other pieces are given actual size on the following page.

1. Pick out two No. 12 half logs.

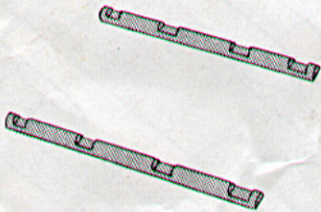

2. Use two No. 5 logs to connect the ends of the two No. 12 logs.

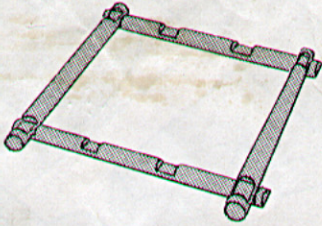

3. Lay a No. 10 log over the No. 12 half log at rear.

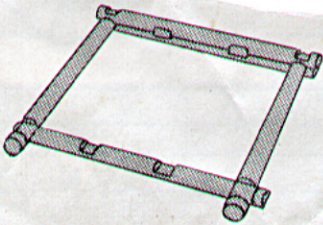

6. Follow the numbers in the top right illustration of the foundation plan. Build as high as your particular building may indicate or as high as you have logs. Then read gable and roof instructions.

#### HOW TO START YOUR BUILDING— A FOUNDATION PLAN

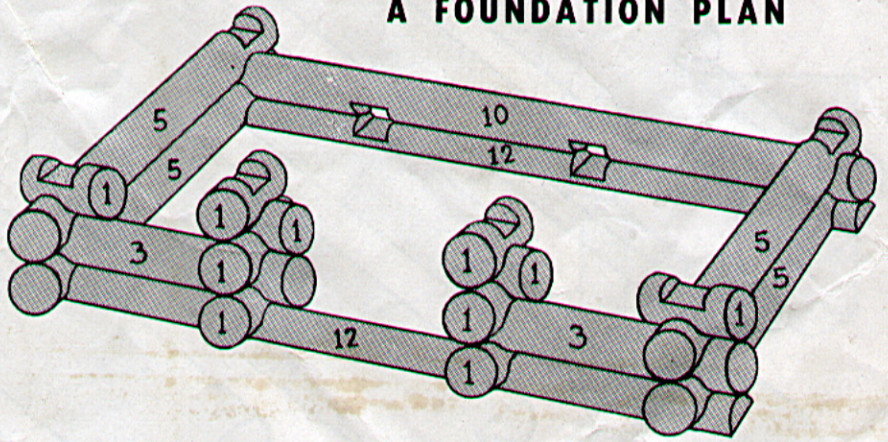

4. Place a No. 1 log on each of the middle notches of the front No. 12 half log.

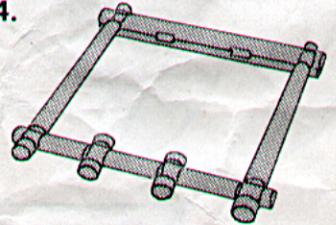

5. Connect No. 1 logs with the side pieces (No. 5 logs) by using two No. 3 logs.

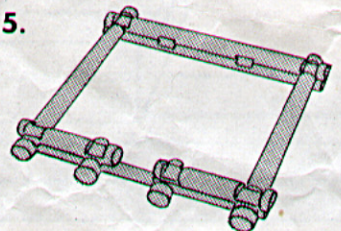

#### HOW TO COMPLETE YOUR BUILDING—ROOF AND GABLE CONSTRUCTION

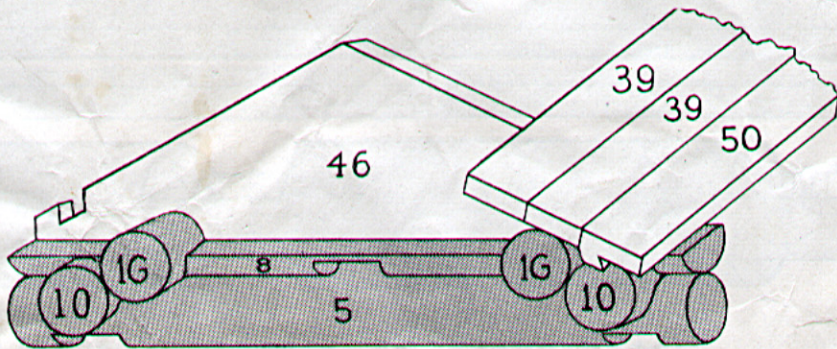

1. When building has reached desired height, take two No. 8 logs and place one on the uppermost logs at each end of the building.

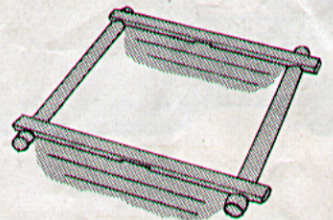

3. The gables, No. 46, fit into the grooves of the No. 1G logs and hold the roof planks.

4. Roof planks No. 50 fit into the notches of the gables and roof planks No. 39 lay in sequence upward to the gable peaks.

2. Place two No. 1G logs on each of the No. 8 logs.

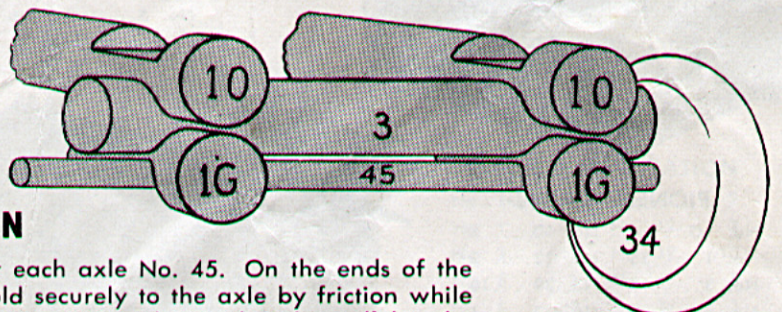

#### WHEEL AND AXLE CONSTRUCTION

Two grooved logs No. 1G are used as bearings for each axle No. 45. On the ends of the axles are placed the wheels No. 34. The wheels hold securely to the axle by friction while the axle turns freely in the grooves of the No. 1G logs. A No. 3 log is placed parallel to the axle in the large notches of the No. 1G logs, then longer logs (such as No. 10 logs) are placed in the notches of the No. 3 logs to form the chassis. Any desired body type can now be constructed.

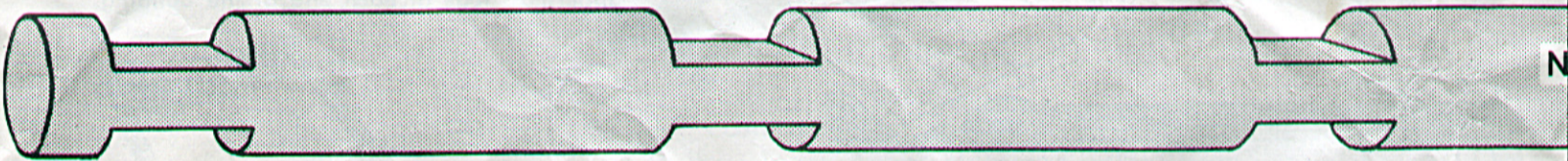
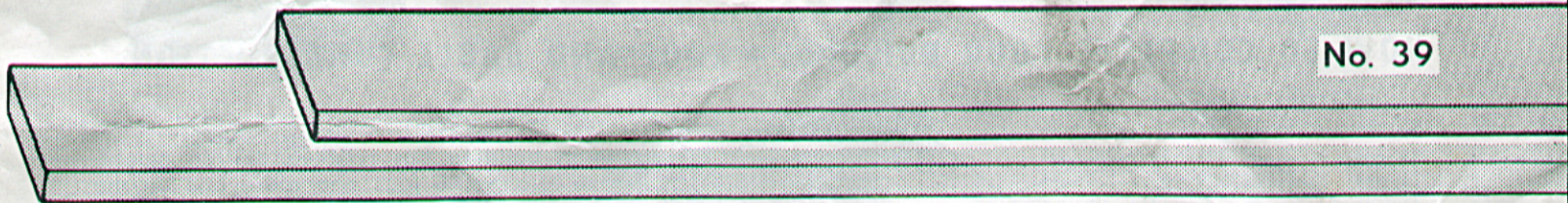
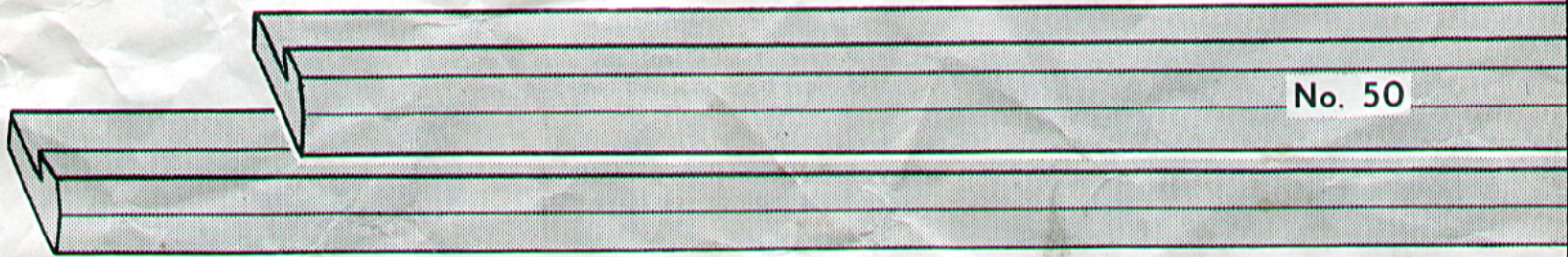
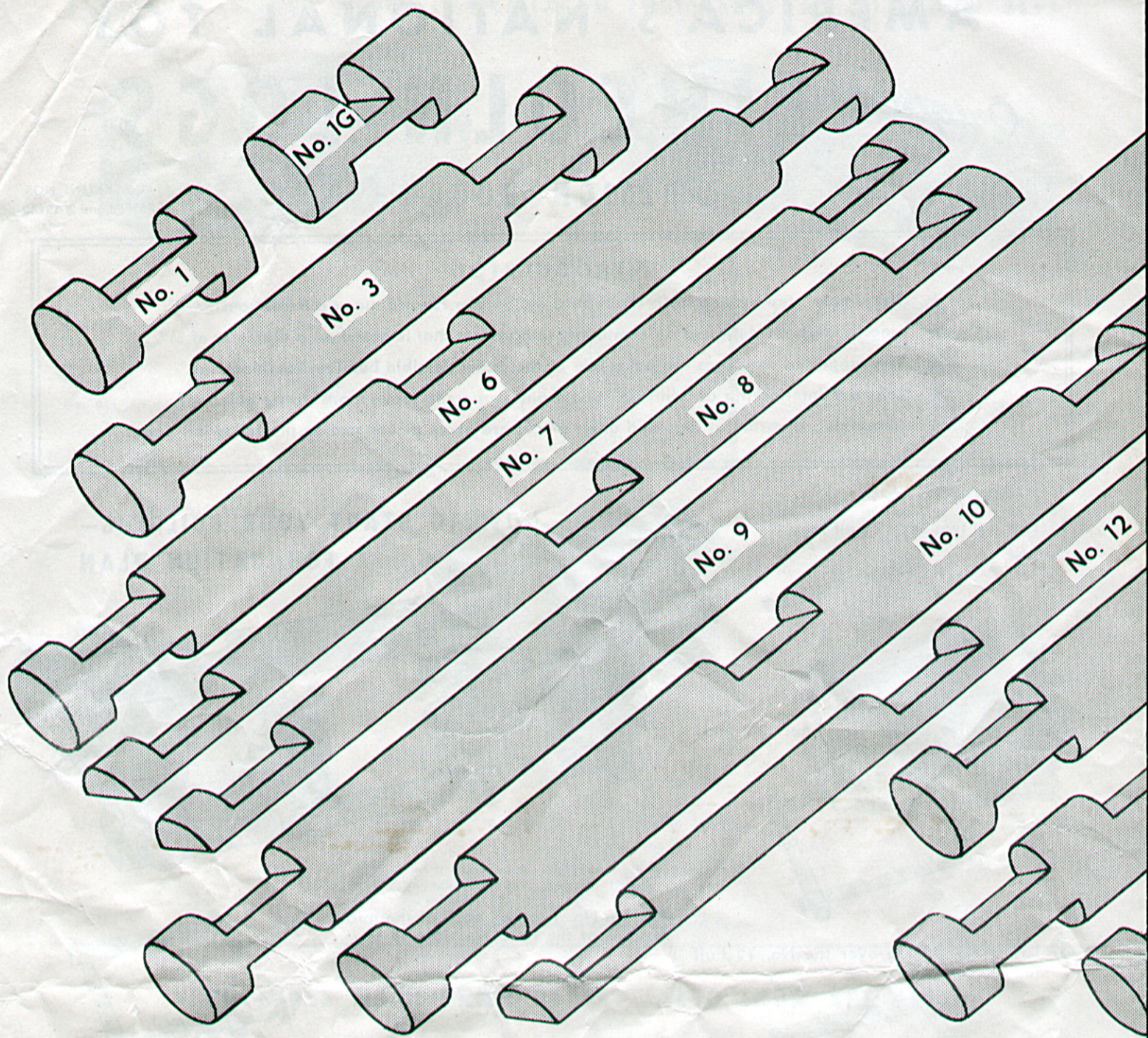

**STRUCTURES MADE FROM 1L SET (ALL)**

FRONT

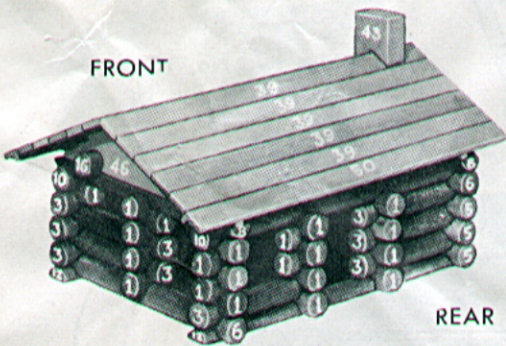

**PIONEER CABIN**

- |             |              |
|-------------|--------------|
| No. 1G... 4 | No. 10... 2  |
| No. 1... 33 | No. 12... 2  |
| No. 3... 10 | No. 39... 10 |
| No. 5... 3  | No. 43... 1  |
| No. 6... 2  | No. 46... 2  |
| No. 8... 2  | No. 50... 2  |

**MILK TRUCK**

- |             |             |
|-------------|-------------|
| No. 1G... 4 | No. 6... 2  |
| No. 1... 12 | No. 10... 2 |
| No. 3... 8  | No. 12... 2 |
| No. 5... 2  | No. 34... 4 |
| No. 45... 2 |             |

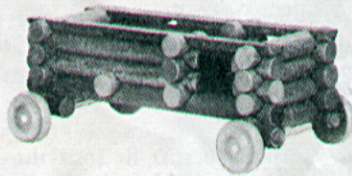

**CONTENT**

- |             |
|-------------|
| No. 1G... 4 |
| No. 1... 33 |
| No. 3... 10 |
| No. 5... 3  |
| No. 6... 2  |
| No. 8... 2  |
| No. 10... 2 |
| Total 0     |

REAR

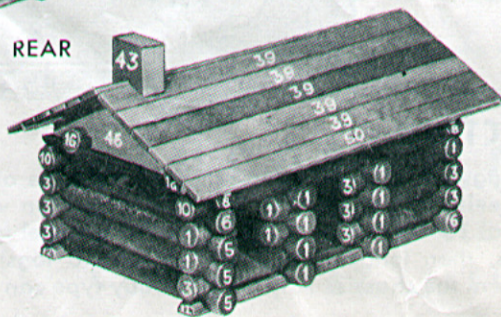

- |             |
|-------------|
| No. 1... 16 |
| No. 3... 2  |
| No. 39... 2 |

**BRIDGE**



- |             |
|-------------|
| No. 1... 16 |
| No. 3... 2  |
| No. 39... 2 |

# DIAGRAM OF PIECES - ACTUAL SIZE

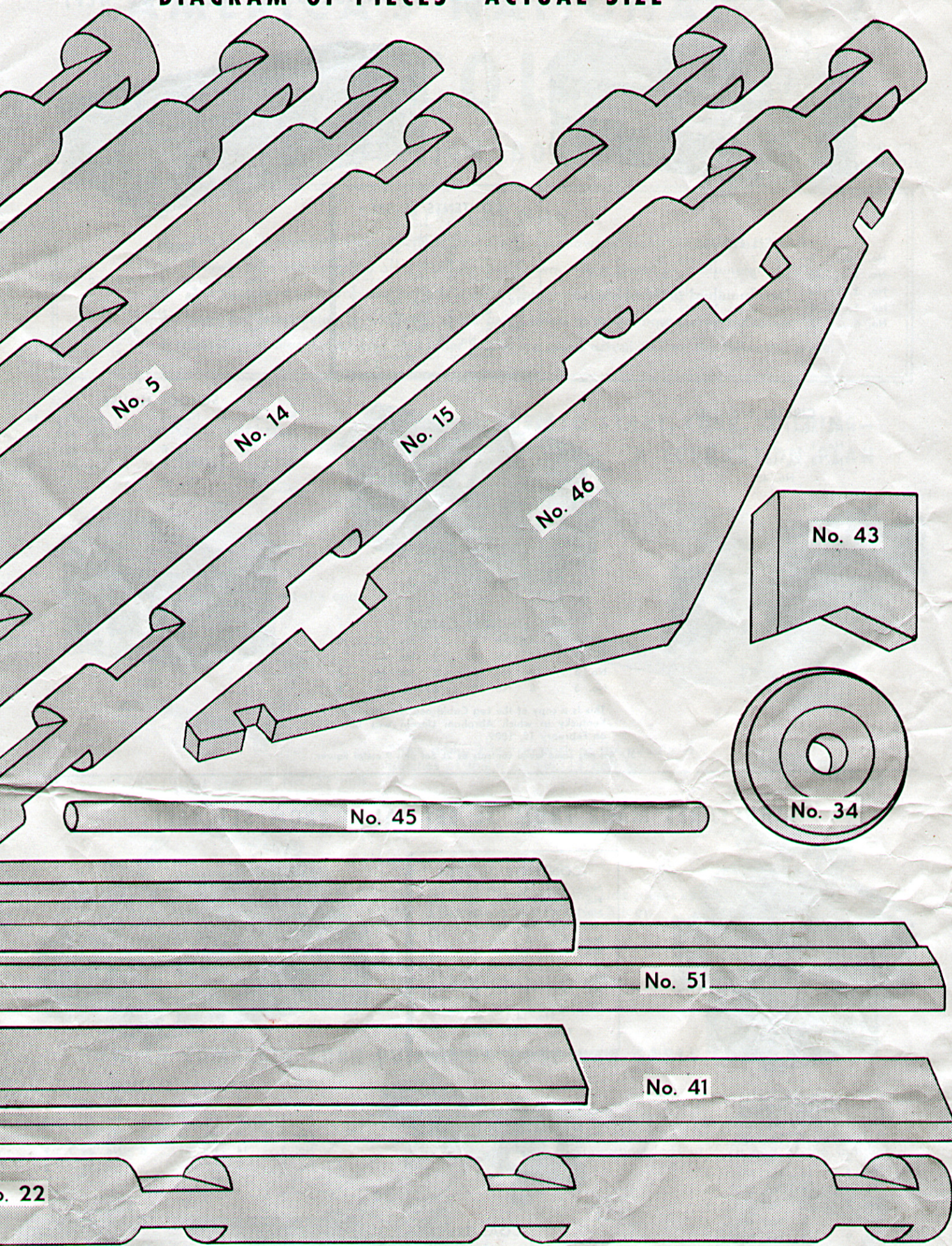

## 0 FROM SETS 2L, 3L, 3LF AND 4LF)

**OF 1L SET**

No. 12....	2
No. 34....	4
No. 39....	10
No. 43....	1
No. 45....	2
No. 46....	2
No. 50....	2

77 pieces

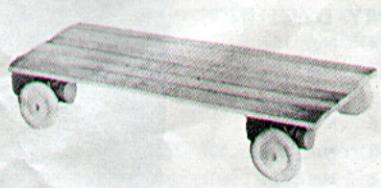

### FLAT WAGON

No. 1G...	4	No. 34....	4
No. 12....	2	No. 39....	6
No. 45.... 2			

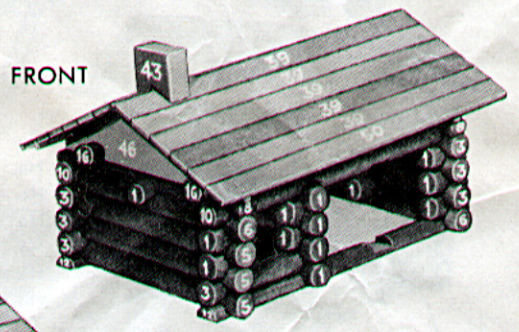

### FRONT

### REAR

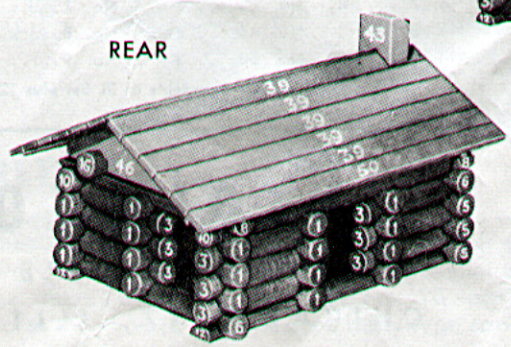

### PONY EXPRESS STATION

No. 1G....	4	No. 10....	2
No. 1....	27	No. 12....	2
No. 3....	10	No. 39....	10
No. 5....	3	No. 43....	1
No. 6....	2	No. 46....	2
No. 8....	2	No. 50....	2

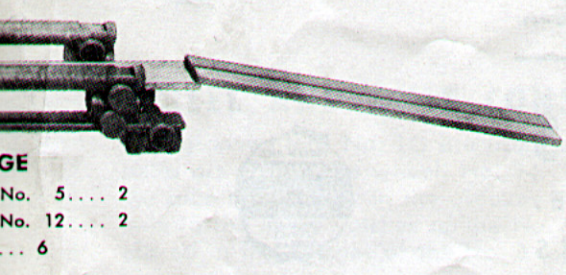

### GE

No. 5....	2
No. 12....	2
....	6

## STRUCTURES MADE FROM 2L SET (ALSO FROM SETS 3L, 3LF, AND 4LF)

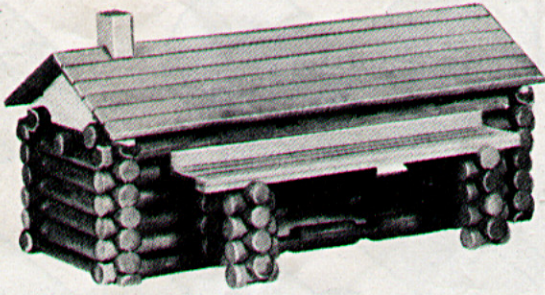

### RANCH HOUSE

No. 1G... 4	No. 7... 1	No. 39... 5
No. 1... 46	No. 8... 3	No. 41... 10
No. 3... 10	No. 9... 1	No. 43... 1
No. 5... 8	No. 10... 1	No. 46... 2
No. 6... 2	No. 22... 4	No. 51... 2

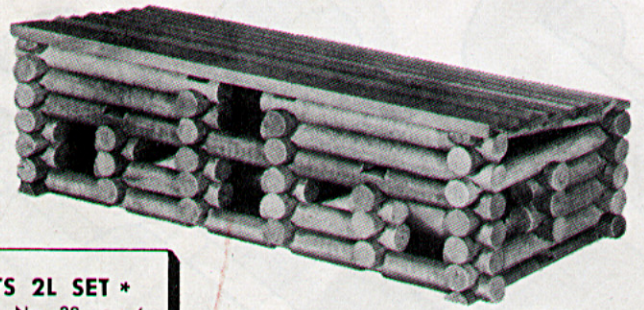

### SHED

No. 1... 47	No. 8... 3
No. 3... 4	No. 9... 2
No. 5... 8	No. 10... 1
No. 6... 2	No. 22... 4
No. 7... 1	No. 41... 9
No. 51... 1	

### CONTENTS 2L SET \*

No. 1G... 4	No. 22... 4
No. 1... 56	No. 34... 4
No. 3... 10	No. 39... 10
No. 5... 9	No. 41... 10
No. 6... 2	No. 43... 2
No. 7... 1	No. 45... 2
No. 8... 3	No. 46... 2
No. 9... 2	No. 50... 2
No. 10... 4	No. 51... 2
No. 12... 2	
Total of 131 pieces	

### CIRCUS WAGON

No. 1G... 4	No. 9... 2
No. 1... 23	No. 10... 4
No. 3... 10	No. 34... 4
No. 45... 2	

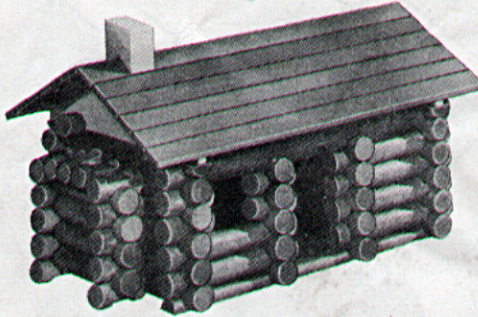
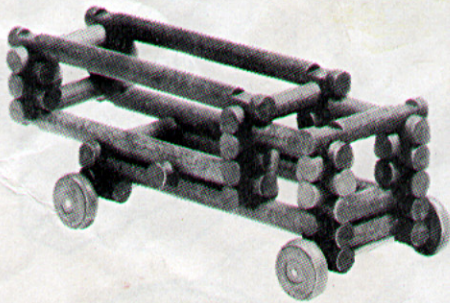

### LINCOLN CABIN

No. 1G... 4	No. 6... 2	No. 39... 10
No. 1... 49	No. 8... 2	No. 43... 1
No. 3... 10	No. 10... 2	No. 46... 2
No. 5... 8	No. 12... 2	No. 50... 2

This is a copy of the Log Cabin near Hodgenville, Kentucky in which Abraham Lincoln was born on February 12, 1809.

\*3LF Set has same wood contents as 2L Set plus 9 metal figures.

### SCHOOL HOUSE

No. 1G... 4	No. 6... 2	No. 39... 10
No. 1... 47	No. 7... 1	No. 43... 1
No. 3... 9	No. 8... 3	No. 46... 2
No. 5... 7	No. 9... 2	No. 50... 2
No. 10... 4		

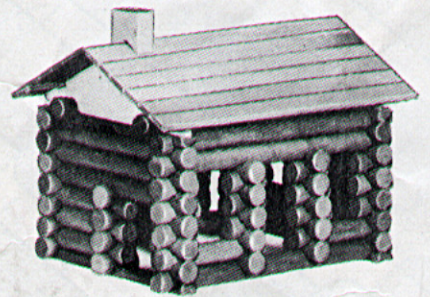

## STRUCTURES MADE FROM 3L SET (ALSO FROM SET 4LF)

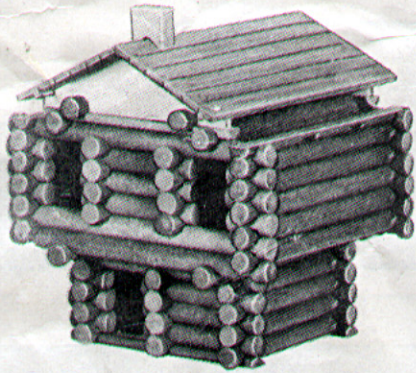

### BLOCK HOUSE

No. 1G... 4	No. 10... 4
No. 1... 42	No. 12... 2
No. 3... 9	No. 14... 4
No. 5... 16	No. 15... 2
No. 6... 3	No. 39... 10
No. 7... 1	No. 43... 1
No. 8... 3	No. 46... 2
No. 9... 7	No. 50... 2

### CONTENTS 3L SET \*

No. 1G... 4	No. 15... 2
No. 1... 77	No. 22... 6
No. 3... 14	No. 34... 4
No. 5... 16	No. 39... 10
No. 6... 3	No. 41... 10
No. 7... 1	No. 43... 2
No. 8... 3	No. 45... 2
No. 9... 7	No. 46... 2
No. 10... 4	No. 50... 2
No. 12... 2	No. 51... 2
No. 14... 4	
Total of 177 pieces	

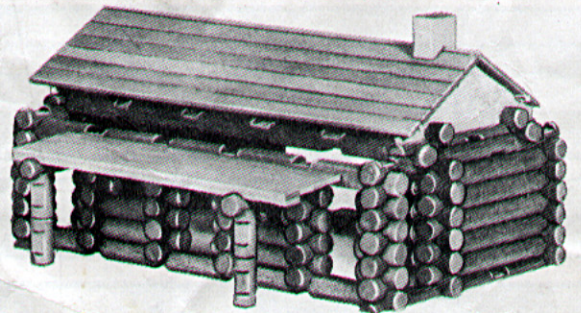

### RAILWAY STATION

No. 1G... 4	No. 8... 1	No. 39... 5
No. 1... 68	No. 12... 2	No. 41... 10
No. 3... 6	No. 15... 2	No. 43... 1
No. 5... 14	No. 22... 6	No. 46... 2
No. 7... 1	No. 51... 2	

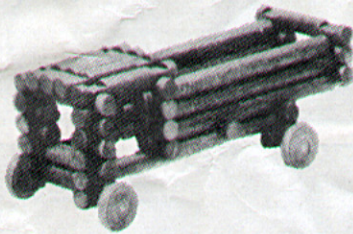

### COAL TRUCK

No. 1G... 4	No. 9... 4
No. 1... 20	No. 10... 4
No. 3... 13	No. 34... 4
No. 45... 2	

### MEETING HOUSE

No. 1G... 4	No. 10... 4
No. 1... 38	No. 12... 2
No. 3... 8	No. 14... 1
No. 5... 16	No. 39... 10
No. 7... 1	No. 43... 1
No. 8... 1	No. 46... 2
No. 9... 5	No. 50... 2

### TWO STORY DWELLING

No. 1G... 4	No. 10... 4
No. 1... 47	No. 12... 2
No. 3... 13	No. 14... 1
No. 5... 15	No. 15... 2
No. 6... 3	No. 39... 10
No. 7... 1	No. 43... 1
No. 8... 1	No. 46... 2
No. 9... 7	No. 50... 2

\*4LF Set has same wood contents as 3L Set plus 12 metal figures.

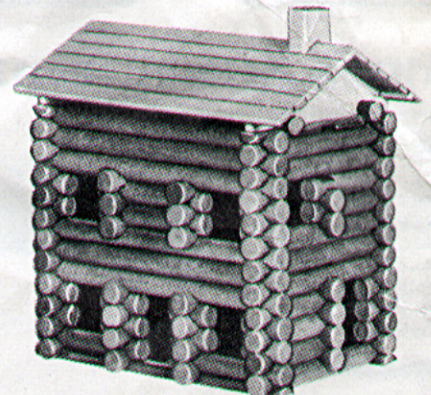
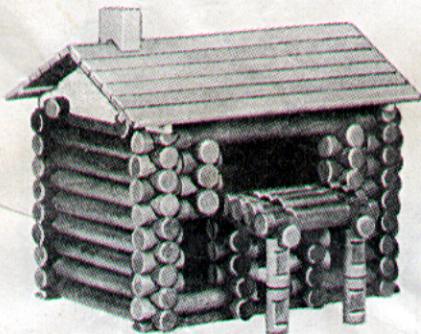

**LINCOLN LOGS**  
1750 N. LAWNDALE AVE.  
CHICAGO 47, ILLINOIS

